

99240

Dimensions

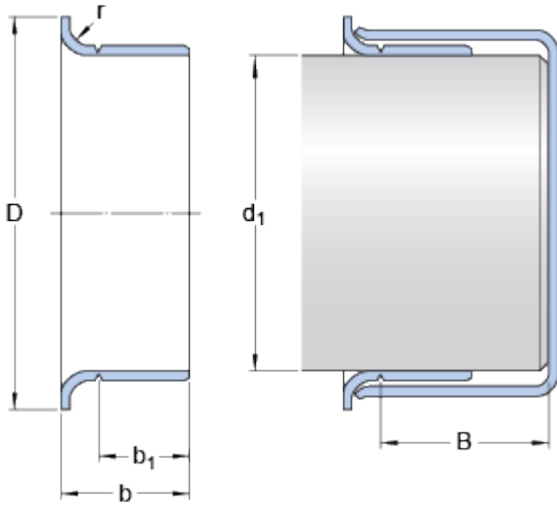

Nominal dimensions

d_1		60.325	mm
D		69.85	mm
Tolerance outside diameter D	\pm	1.6	mm
b		17.348	mm
Tolerance width b	\pm	0.8	mm
b_1		13.36	mm
Tolerance width b_1	\pm	0.8	mm
B	max.	34.925	mm
r	max.	3.18	mm

Shaft diameter range

d_1	min.	60.3	mm
d_1	max.	60.452	mm